

EK 500

Instructions for use

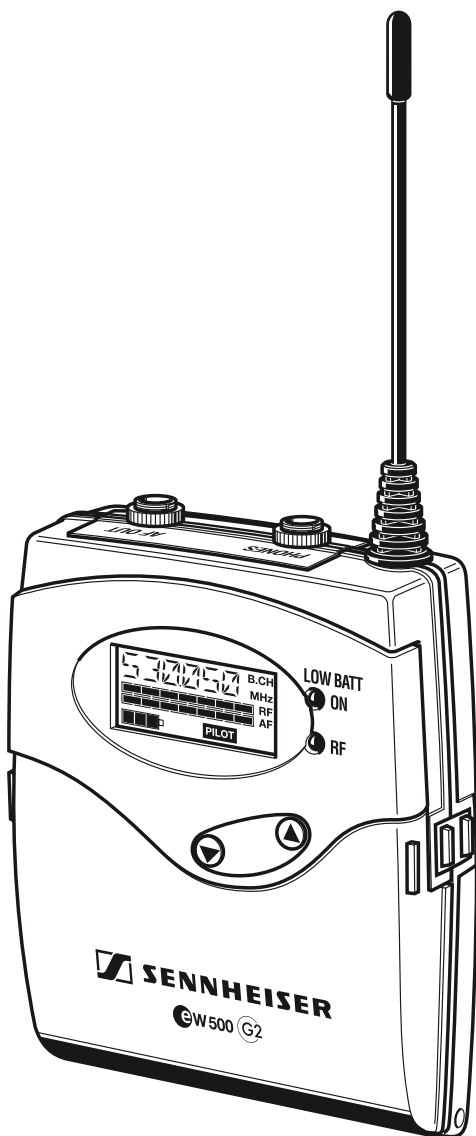



Thank you for choosing Sennheiser!

We have designed this product to give you reliable operation over many years. Over half a century of accumulated expertise in the design and manufacture of high-quality electro-acoustic equipment have made Sennheiser a world-leading company in this field.

Please take a few moments to read these instructions carefully, as we want you to enjoy your new Sennheiser product quickly and to the fullest.

Contents

The EK 500 G2 receiver	4
The channel bank system	4
Safety instructions	5
Areas of application	6
Delivery includes	6
The operating controls	7
Indications and displays	8
LC display panel	8
Indications and displays of the receiver	8
Remote displays of an ew 500 G2 transmitter	10
Preparing the receiver for use	11
Inserting and replacing the batteries	11
Inserting and charging the accupack	11
Connecting units to the audio output	12
Mounting the receiver to a camera	12
Attaching the receiver to clothing	13
Using the receiver	14
Switching the receiver on/off	14
Connecting the headphones	14
Activating/deactivating the lock mode	15
The operating menu	16
The buttons	16
Overview of menus	17
Working with the operating menu	17
Operating menu of the receiver	19
Adjustment tips for the operating menu	21
Switching between channel banks	21
Switching between the channels in a channel bank ..	21
Selecting the frequencies to be stored in the channel bank "U"	21
Scanning the channel banks for free channels	22
Multi-channel operation	22
Adjusting the audio output level	23
Adjusting the squelch threshold	23
Selecting the standard display	24
Entering a name	24
Loading the factory-preset default settings	24
Activating/deactivating the pilot tone evaluation ...	25
Activating/deactivating the lock mode	25
Exiting the operating menu	25
Troubleshooting	26
Error checklist	26
Recommendations and tips	27
Care and maintenance	27
Additional information	28
HDX noise reduction	28
Wireless transmission systems	28
Squelch	29
Specifications	30
Connector assignment	31
Accessories	31
Manufacturer declarations	32
Warranty regulations	32
CE Declaration of Conformity	32
Batteries or rechargeable batteries	32
WEEE Declaration	32

The EK 500 G2 receiver

The EK 500 G2 bodypack receiver is part of the evolution wireless series ew 500 G2. With this series, Sennheiser offers high-quality state-of-the-art RF transmission systems with a high level of operational reliability and ease of use. Transmitters and receivers permit wireless transmission with studio-quality sound. The excellent transmission reliability of the ew 500 G2 series is based on the use of

- further optimized PLL synthesizer and microprocessor technology,
- the HDX noise reduction system,
- the pilot tone squelch control,
- and the scan function for scanning the channel banks for free channels.

The channel bank system

The receiver is available in five UHF frequency ranges with 1440 receiving frequencies per frequency range. Please note: Frequency usage is different for each country. Your Sennheiser agent will have all the necessary details on the available legal frequencies for your area.

Range A: 518 to 554 MHz

Range B: 626 to 662 MHz

Range C: 740 to 776 MHz

Range D: 786 to 822 MHz

Range E: 830 to 866 MHz

The receiver has nine channel banks with up to 20 switchable channels each.

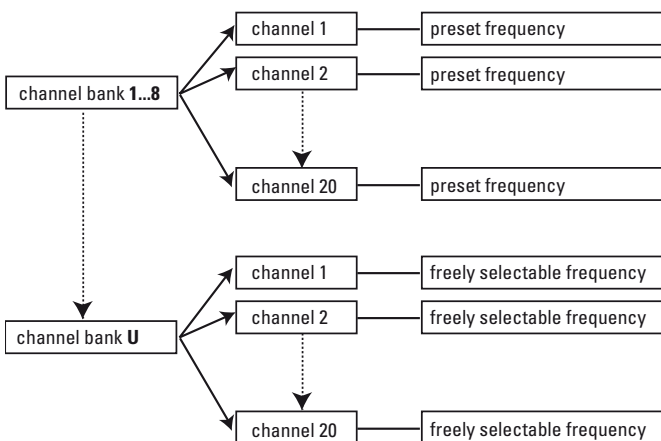

Each of the channels in the channel banks "1" to "8" has been factory-preset to a receiving frequency (see enclosed frequency table). These receiving frequencies cannot be changed but have been preset so that e.g. country-specific regulations on frequency usage are taken into account.

The channel bank "U" (user bank) allows you to store your selection out of 1440 receiving frequencies that are freely selectable within the preset frequency range.

Safety instructions

Never open an electronic unit! If units are opened by customers in breach of this instruction, the warranty becomes null and void.

Use the unit in dry rooms only.

Use a damp cloth for cleaning the unit. Do not use any cleansing agents or solvents.



Attention! High Volume!

This is a professional transmission system. Commercial use is subject to the rules and regulations of the trade association responsible. Sennheiser, as the manufacturer, is therefore obliged to expressly point out possible health risks arising from use.

This system is capable of producing sound pressure exceeding 85 dB(A). 85 dB(A) is the sound pressure corresponding to the maximum permissible volume which is by law (in some countries) allowed to affect your hearing for the duration of a working day. It is used as a basis according to the specifications of industrial medicine. Higher volumes or longer durations can damage your hearing. At higher volumes, the duration must be shortened in order to prevent damage. The following are sure signs that you have been subjected to excessive noise for too long a time:





- You can hear ringing or whistling sounds in your ears.
- You have the impression (even for a short time only) that you can no longer hear high notes.

Areas of application

The receiver can be combined with transmitters of the ew 500 G2 series (SK 500 G2 bodypack transmitter, SKM 500 G2 radiomicrophone or SKP 500 G2 plug-on transmitter). The transmitters are available in the same five UHF frequency ranges and are equipped with the same channel bank system with factory-preset frequencies. An advantage of the factory-preset frequencies is that

- a transmission system is ready for immediate use after switch-on,
- several transmission systems can be operated simultaneously on the preset frequencies without causing intermodulation interference.

Together with a matching transmitter and a microphone, the receiver is suitable for the following areas of application:

Receiver	Transmitter (to be ordered separately)	Area of application
EK 500 G2 	SK 500 G2 	<ul style="list-style-type: none"> • Theater • Presentation • Sports (aerobic) • Vocals • Using instruments wirelessly • Camera-mounted applications
	SKM 500 G2 	<ul style="list-style-type: none"> • Speech • Vocals • Presentation • Camera-mounted applications
	SKP 500 G2 	<ul style="list-style-type: none"> • Speech • Vocals • Presentation • Camera-mounted applications

Delivery includes

The packaging contains the following items:

- 1 EK 500 G2 bodypack receiver
- 2 batteries
- 1 camera kit
- 1 bodypack pouch
- 1 line cable with 3.5 mm jack plug
- 1 line output cable with XLR-3 plug
- Instructions for use

The operating controls

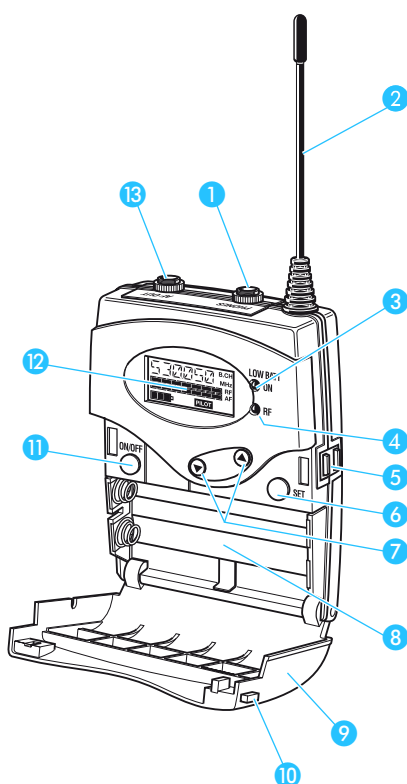

- ① Headphone output (PHONES), 3.5 mm jack socket
- ② Antenna
- ③ Red LED for operation and battery status indication (ON/LOW BAT)
- ④ Green LED for RF signal indication (RF)
- ⑤ Charging contacts
- ⑥ SET button
- ⑦ ▼/▲ rocker button (DOWN/UP) and adjust the headphone volume
- ⑧ Battery compartment
- ⑨ Battery compartment cover
- ⑩ Unlocking button
- ⑪ ON/OFF button (serves as the ESC (cancel) key in the operating menu)
- ⑫ LC display
- ⑬ Audio output (AF OUT), 3.5 mm jack socket (balanced)

Indications and displays

LC display panel

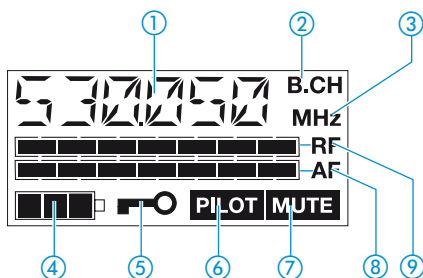

- ① Alphanumeric display
- ② "B.CH" – appears when the channel bank and the channel number are displayed
- ③ "MHz" – appears when the frequency is displayed
- ④ 4-step battery status display
- ⑤ Lock mode icon (lock mode is activated)
- ⑥ "PILOT" display (pilot tone evaluation is activated)
- ⑦ "MUTE" display (audio output is muted)
- ⑧ 7-step level display for received audio signal "AF"
- ⑨ 7-step level display for received RF signal "RF"

Indications and displays of the receiver

When used together with an ew 500 G2 transmitter, the receiver provides information on its operating states and those of the received transmitter (remote displays).

Operation and battery status indication

The red LED (LOW BAT/ON) ③ provides information on the current operating state of the receiver:

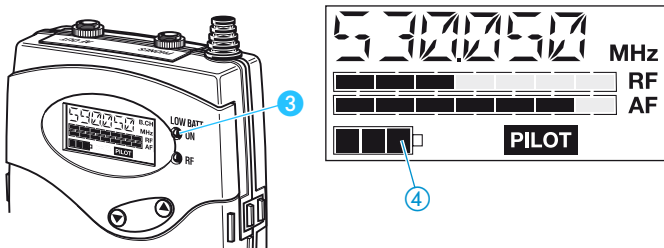

Red LED lit up:

The receiver is switched on and the capacity of the batteries/BA 2015 accupack is sufficient.

Red LED flashing:

The batteries are/the BA 2015 accupack is going flat (LOW BAT)!

In addition, the 4-step battery status display ④ on the display panel provides information on the remaining battery/BA 2015 accupack capacity:

- 3 segments: capacity approx. 100 %
- 2 segments: capacity approx. 70 %
- 1 segment: capacity approx. 30 %
- Battery icon flashing: LOW BAT

RF signal indication

The green LED (RF) ④ at the front of the receiver lights up when an RF signal is being received.

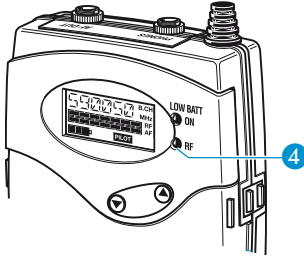

“PILOT” display

The “PILOT” display ⑥ appears on the display panel when the pilot tone evaluation is activated (see “Activating/deactivating the pilot tone evaluation” on page 25).

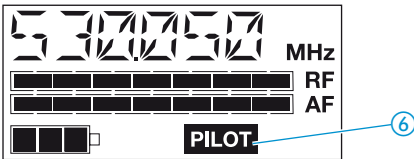

Display backlighting

After pressing a button, the display remains backlit for approx. 15 seconds.

Remote displays of an ew 500 G2 transmitter

“MUTE” display

The “MUTE” display ⑦ appears on the display panel when

- the RF signal of the received transmitter is too weak,
- the received transmitter has been muted (with the pilot tone transmission or evaluation activated).



Modulation display

The level display for audio signal “AF” shows the modulation of the received transmitter.

When the transmitter’s audio input level is excessively high, the receiver’s level display for audio signal “AF” ⑥ shows full deflection.

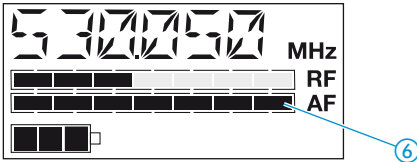

Preparing the receiver for use

Inserting and replacing the batteries

For powering the receiver, two 1.5 V AA size batteries are required.

- ▶ Press the two unlocking buttons **10** and open the battery compartment cover **9**.

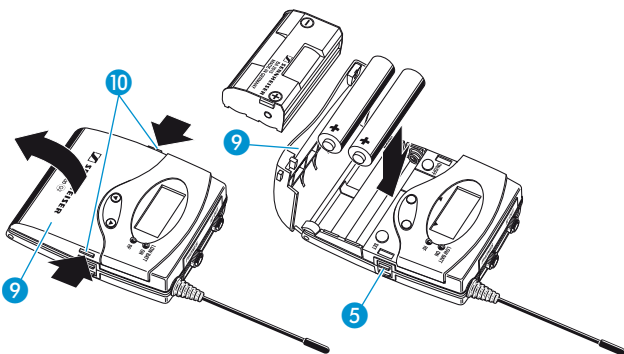

- ▶ Insert the two batteries as shown above. Please observe correct polarity when inserting the batteries.
- ▶ Close the battery compartment. The battery compartment cover **9** locks into place with an audible click.

Inserting and charging the accupack

The receiver can also be powered via the rechargeable Sennheiser BA 2015 accupack. Insert the accupack into the battery compartment as described above.

The receiver has two charging contacts **5** and a sensing contact on its short sides. The accupack can be recharged while remaining in the receiver. Insert the receiver into the L 2015 charger (see operating manual of the L 2015 charger).

Note:

For accupack operation of the receiver, only use the BA 2015 accupack in order to ensure optimum operational reliability. For charging the accupack, only use the L 2015 charger. Both the accupack and the charger are available as accessories.

The accupack is fitted with an integrated sensor which is – via a third contact – monitored by the electronics of the receiver and the charger. The sensor is necessary for the following control purposes:

- The taking into account of the different voltage characteristics of primary cells (batteries) and accupacks. The battery status indications on the displays and the switch-off thresholds at the end of the operating time

are corrected correspondingly. Due to the missing sensor, individual rechargeable battery cells will not be identified as accupacks.

- The monitoring of the accupack temperature during charging in the L 2015 charger.
- The prevention of improper charging of inserted primary cells (batteries). Due to the missing sensor, individual rechargeable battery cells will also not be charged in the L 2015 charger.

Connecting units to the audio output

You can connect a PA system or a recording unit (e.g. video camera) to the receiver.

- ▶ Connect one of the supplied line output cables to the recording unit.
- ▶ Connect the 3.5 mm jack plug to the audio output (AF OUT) 12.

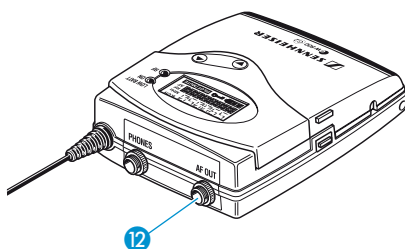

- ▶ Lock the 3.5 mm jack plug by screwing down the coupling ring.
- ▶ Via the operating menu, adapt the level of the audio output (AF OUT) to the input sensitivity of the connected unit (see "Adjusting the audio output level" on page 23).

Mounting the receiver to a camera

Use the supplied camera kit to mount the receiver to the camera's flash mount.

The camera kit consists of:

- 1 perforated plate 12
 - 1 flash mount adapter 13
 - 2 square nuts 14
- ▶ Determine where on the perforated plate the flash mount adapter 13 will need to be fastened so that the receiver can best be attached to the camera.
 - ▶ At this position, place a square nut 14 under the perforated plate 12.

- ▶ Fasten the flash mount adapter to the perforated plate using the square nut.

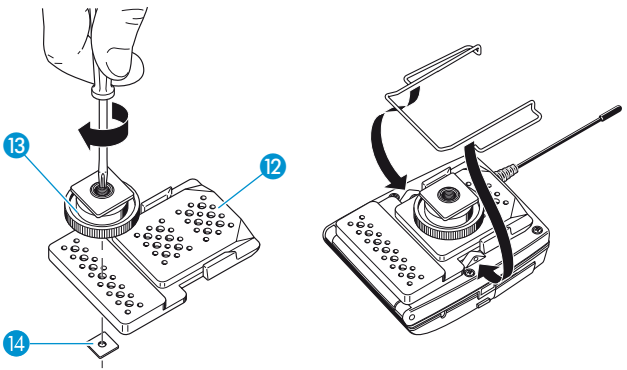

- ▶ Remove the belt clip.
- ▶ Place the perforated plate 12 onto the rear of the receiver.
- ▶ Reinsert the belt clip.

Attaching the receiver to clothing

The receiver is attached to clothing (e.g. belt, waistband) with the supplied belt clip.

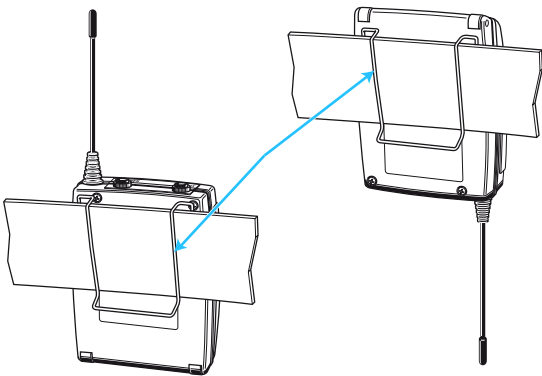

The clip is detachable so that you can also attach the receiver with the antenna pointing downwards. To do so, withdraw the clip from its fixing points and attach it the other way round.

The supplied bodypack pouch helps to protect the receiver against moisture.

Using the receiver

Switching the receiver on/off

The receiver can only be switched off when the standard display is shown on the display panel. When in the operating menu, briefly pressing the **ON/OFF** button will cancel your entry (ESC function) and return you to the standard display with the last stored settings.

Note:

Remove the batteries or the accupack when the receiver will not be used for extended periods of time.

- ▶ Press the two unlocking buttons **10** and open the battery compartment cover **9**.

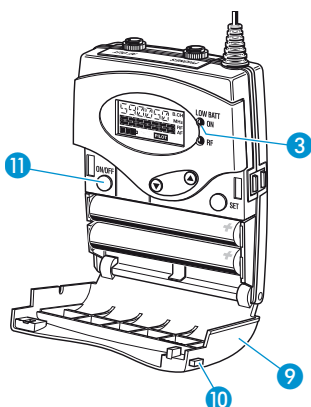

- ▶ Press the **ON/OFF** button **11** to switch the receiver on. The red LED **3** lights up.
- ▶ To switch the receiver off, press the **ON/OFF** button **11** until "OFF" appears on the display. The red LED **3** goes off.
- ▶ Close the battery compartment. The battery compartment cover **9** locks into place with an audible click.

Connecting the headphones

- ▶ To monitor the audio signal, connect headphones with a 3.5 mm jack plug to the headphone output (PHONES) **1**.

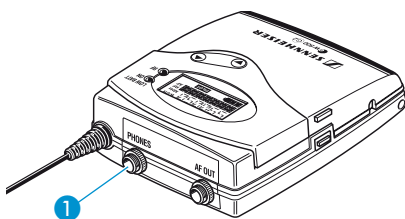

Attention! High volume!

Even short exposure to high volume levels will damage your hearing!

Set the volume for the connected headphones to the minimum before putting the headphones on.

- ▶ First, use the ▼/▲ rocker button to set the volume for the connected headphones to the minimum. Then gradually increase the volume.

Volume up? – NO!

When people use headphones, they tend to choose a higher volume than with loudspeakers. Listening at high volume levels for long periods can lead to permanent hearing defects. Please protect your hearing, Sennheiser headphones have an excellent sound quality even at low volumes.

Activating/deactivating the lock mode

The receiver has a lock mode that can be activated or deactivated via the operating menu (see “Activating/deactivating the lock mode” on page 25). The lock mode prevents that the receiver is accidentally programmed or switched off during operation.

The operating menu

A special feature of the Sennheiser ew 500 G2 series is the similar, intuitive operation of transmitters and receivers. As a result, adjustments to the settings can be made quickly and “without looking” – even in stressful situations, for example on stage or during a live show or presentation.

The buttons

Buttons	Mode	To...
ON/OFF	Standard display	switch the receiver on and off
	Operating menu	cancel the entry and return to the standard display
	Setting mode	cancel the entry and return to the standard display
SET	Standard display	get into the operating menu
	Operating menu	get into the setting mode of the selected menu
	Setting mode	store the settings and return to the top menu level
▲/▼	Standard display	adjust the headphone volume
	Operating menu	change to the previous menu (▲) or change to the next menu (▼)
	Setting mode	adjust the setting of the selected menu: option (▲/▼)

Overview of menus

Display	Function of the menu
BANK	Switching between channel banks
CHAN	Switching between the channels in a channel bank
TUNE	Setting a receiving frequency for the channel bank "U" (user bank)
SCAN	Scanning the channel banks for free channels
AF OUT	Adjusting the audio output level
SQELCH	Adjusting the squelch threshold
DISPLY	Selecting the standard display
NAME	Entering a name
RESET	Loading the factory-preset default settings
PILOT	Activating/deactivating the pilot tone evaluation
LOCK	Activating/deactivating the lock mode
EXIT	Exiting the operating menu and returning to the standard display

Working with the operating menu

By way of example of the "TUNE" menu, this section describes how to use the operating menu.

After switching the receiver on, the standard display is shown on the display panel.

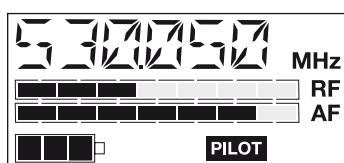

Getting into the operating menu

- ▶ Press the **SET** button to get from the standard display into the operating menu. The last selected menu flashes on the display.

Selecting a menu

- ▶ Press the **▲/▼** rocker button to select a menu.



- ▶ Press the **SET** button to get into the setting mode of the selected menu. The current setting that can be adjusted flashes on the display.

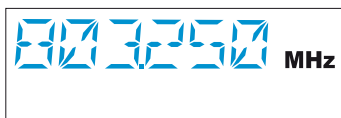

Adjusting a setting

- ▶ Press the **▲/▼** rocker button to adjust the setting. The new setting becomes effective immediately. By briefly pressing the **▲/▼** rocker button, the display jumps either forwards or backwards to the next setting. In the "**CHAN**", "**TUNE**" and "**NAME**" menu, the **▲/▼** rocker button features a "fast search" function. If you hold down a button, the display cycles continuously, allowing you to get fast and easily to your desired setting. The new setting flashes on the display until it is stored.



Storing a setting

- ▶ Press the **SET** button to store the setting. "STORED" appears on the display, indicating that the setting has been stored. The display then returns to the top menu level.



Exiting the operating menu

- ▶ Select the "**EXIT**" menu to exit the operating menu and to return to the standard display.



When in the operating menu, briefly pressing the **ON/OFF** button will cancel your entry (ESC function) and return you to the standard display with the last stored settings.

Operating menu of the receiver

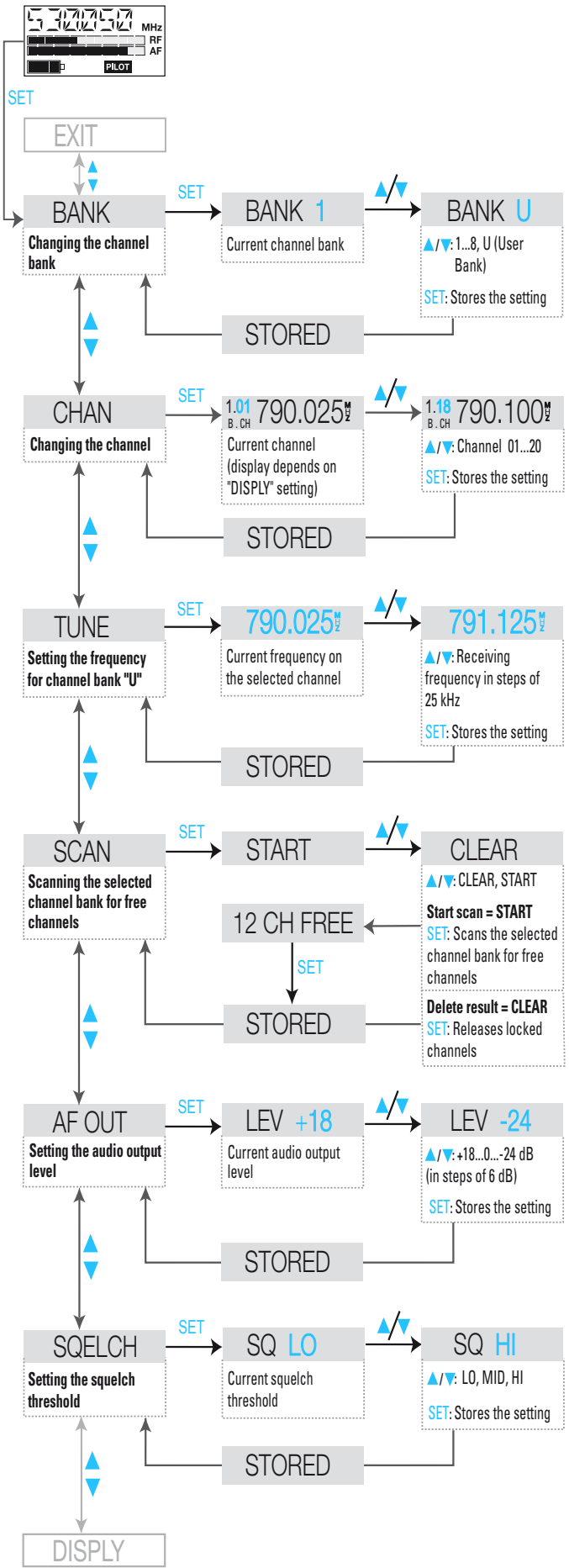

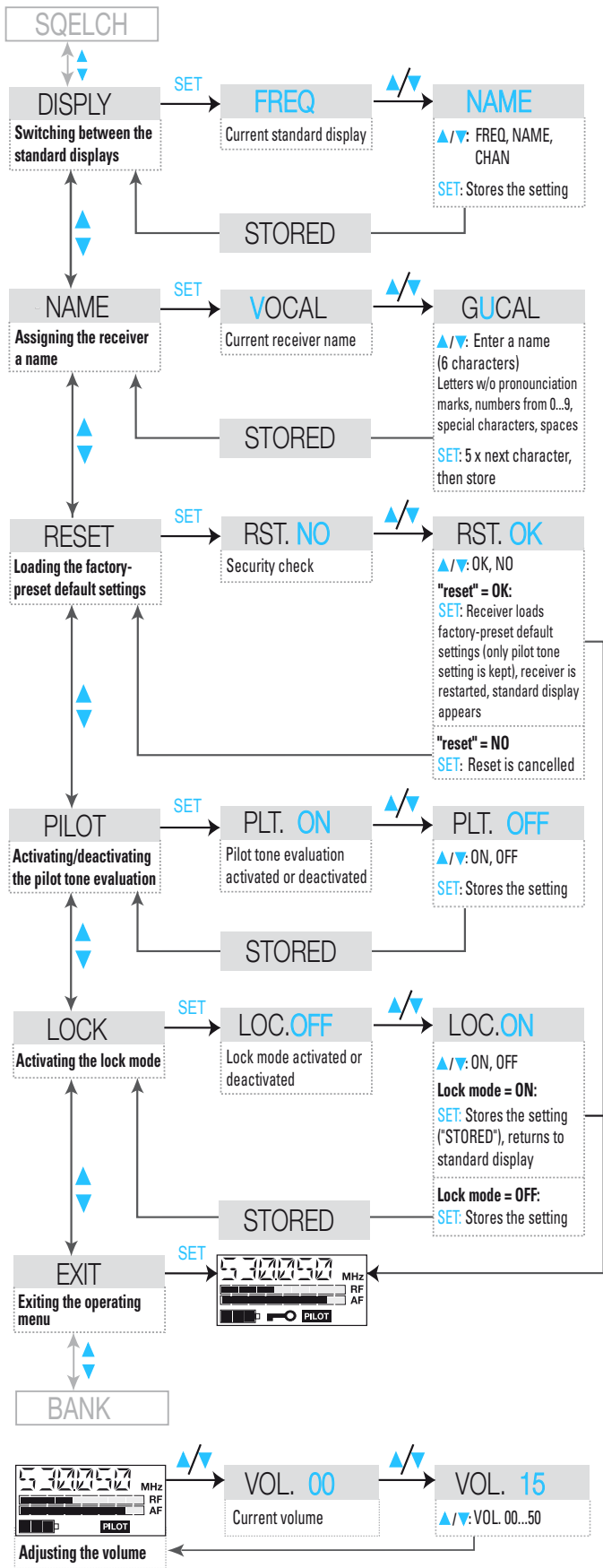

Adjustment tips for the operating menu

Switching between channel banks – **BANK**

Via the “**BANK**” menu, you can switch between the receiver’s nine channel banks. Each of the channel banks “1” to “8” has up to 20 switchable channels that are factory-preset to a receiving frequency (see “The channel bank system” on page 4). The channel bank “U” (user bank) has up to 20 switchable channels to store your selection out of 1440 receiving frequencies that are freely selectable within the preset frequency range.

When switching from one channel bank to another, the channel with the lowest channel number is automatically displayed. If, during the last scan of this channel bank, an interfering frequency was detected on the channel with the lowest channel number (see “Scanning the channel banks for free channels” on page 22), the receiver display panel automatically displays the next free channel.

Switching between the channels in a channel bank – **CHAN**

Via the “**CHAN**” menu, you can switch between the different channels in a channel bank. When switching between the channels, please observe the following:

- Always set the transmitter and the receiver of a transmission link to the same channel.
- After scanning the channel banks (see “Scanning the channel banks for free channels” on page 22), only the free channels can be chosen on the receiver. Set the transmitter and the receiver to one of the free channels.

Selecting the frequencies to be stored in the channel bank “U” – **TUNE**

Via the “**TUNE**” menu, you can select the frequencies to be stored in the channel bank “U” (user bank).

When you have selected one of the channel banks “1” to “8” and then select the “**TUNE**” menu, the receiver automatically switches to channel 01 of the channel bank “U”. In this case, “U.01” briefly appears on the display.



- ▶ Use the ▲/▼ rocker button to select the desired receiving frequency. Your selection becomes effective immediately. Receiving frequencies are tunable in 25-kHz steps within a switching bandwidth of 36 MHz max. For intermodulation-free frequencies, please refer to the enclosed frequency table.

Scanning the channel banks for free channels – SCAN

Before putting one or several ew 500 G2 transmission links into operation, you should scan the channel banks for free channels.

Starting the scan and storing the scan result

- ▶ Before starting the scan, switch all transmitters of your system off, since channels used by switched-on transmitters will not be displayed as “free channels”.
- ▶ Select the channel bank that you want to scan for free channels (see “Switching between channel banks” on page 21).
- ▶ Select the “SCAN” menu.
- ▶ Select “START” and confirm your selection by pressing the SET button. After the scan is completed, the number of free channels is displayed. Pressing the SET button once more will store the scan result and lock all channels that are used or subject to interference.

Releasing locked channels

- ▶ First, select the channel bank whose locked channels you want to release (see “Switching between channel banks” on page 21).
- ▶ Select the “SCAN” menu.
- ▶ Select “CLEAR” and confirm your selection by pressing the SET button. All channels in this channel bank can now be selected again.

Multi-channel operation

Combined with ew 500 G2 transmitters, the receiver can form transmission links that can be used in multi-channel systems. For multi-channel operation, only use the free channels in a channel bank.

Before putting the transmission links into operation, we recommend performing an auto scan.

- ▶ Select a channel bank on a receiver.
- ▶ Scan this channel bank for free channels. If not enough free channels are available in the selected channel bank, repeat the scan with another channel bank.
- ▶ Apply the scan result to all other receivers and transmitters.

Adjusting the audio output level – AF OUT

Via the “AF OUT” menu, you can adjust the audio output level of the receiver. The level can be adjusted in eight steps. Adapt the level of the audio output (AF OUT) to the input of the connected unit. The following figures are a guide to the best settings:

- Line level input: 0 to +18 dB
- Microphone level input: -24 to -6 dB

Adjusting the squelch threshold – SQUELCH

The receiver is equipped with a squelch that can be adjusted via the “SQUELCH” menu. The squelch eliminates annoying noise when the transmitter is switched off. It also suppresses sudden noise when there is no longer sufficient transmitter power received by the receiver.

Note:

Before adjusting the squelch threshold to a different setting, set the volume on a connected amplifier to the minimum.

There are three possible squelch settings:

- LO = low
- MID = middle
- HI = high

Selecting the setting “LO” reduces the squelch threshold, selecting the setting “HI” increases the squelch threshold. Adjust the squelch threshold – with the transmitter switched off – to the lowest possible setting that suppresses hissing noise.

Important notes:

If the squelch threshold is adjusted too high, the transmission range will be reduced. Therefore, always adjust the squelch threshold to the lowest possible setting.

When in the setting mode of the “SQUELCH” menu, pressing the ▼ button (DOWN) for more than three seconds will switch the squelch off. “SQ.OFF” appears on the display. If no RF signal is being received, hissing noise will occur. This setting is for test purposes only.

Selecting the standard display – **DISPLPY**

Via the “**DISPLY**” menu, you can select the standard display:

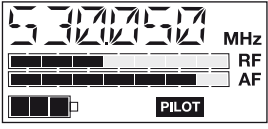
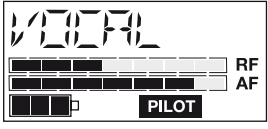
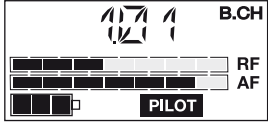
Selectable standard display	Contents of standard display
“FREQ”	
“NAME”	
“CHAN”	

Entering a name – **NAME**

Via the “**NAME**” menu, you can enter a freely selectable name for the receiver. You can, for example, enter the name of the performer for whom the adjustments have been made.

The name can be displayed on the standard display and can consist of up to six characters such as:

- letters (without pronunciation marks),
- numbers from 0 to 9,
- special characters e.g. () - . _ and spaces.

To enter a name, proceed as follows:

- ▶ Press the **SET** button to get into the setting mode of the “**NAME**” menu. The first segment starts flashing on the display.
- ▶ With the **▲/▼** rocker button you can now select a character. By briefly pressing a button, the display jumps either forwards or backwards to the next character. If you hold down a button, the display starts cycling continuously.
- ▶ Press the **SET** button to change to the next segment and select the next character.
- ▶ Have you entered the name completely? Press the **SET** button to store your setting and to return to the top menu level.

Loading the factory-preset default settings – **RESET**

Via the “**RESET**” menu, you can load the factory-preset default settings. Only the selected setting for the pilot tone remains unchanged. After the reset, the receiver is restarted and the standard display is shown on the display panel.

Activating/deactivating the pilot tone evaluation – PILOT

Via the “PILOT” menu, you can activate or deactivate the pilot tone evaluation.

The pilot tone supports the receiver’s squelch function (Squelch) and protects against interference due to RF signals from other units. The transmitter adds an inaudible signal, known as the pilot tone, to the transmitted signal. The receiver detects and evaluates the pilot tone, and is thus able to identify the signal of the matching transmitter and mute all others.

Transmitters of the ew 500 series (first generation) do not transmit a pilot tone and the receivers of the ew 500 series (first generation) cannot evaluate the pilot tone. Nevertheless, you can combine the EK 500 G2 receiver with a transmitter of the first generation. However, when combining units, please observe the following:

- With an ew 500 G2 transmitter and the ew 500 G2 receiver:
Activate the pilot tone function with both transmitter and receiver.
- With an ew 500 transmitter and the ew 500 G2 receiver or vice versa:
Deactivate the pilot tone function with the ew 500 G2 transmitter or receiver.

Activating/deactivating the lock mode – LOCK

Via the “LOCK” menu, you can activate or deactivate the lock mode.

The lock mode prevents that the receiver is accidentally programmed or switched off during operation. The lock mode icon ⑤ on the display indicates that the lock mode is activated.

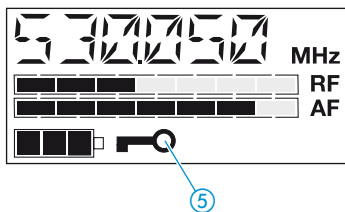

To deactivate the lock mode, first press the SET button and then press the ▲/▼ rocker button to select “LOC.OFF”. If you confirm your selection by pressing the SET button, the buttons can be operated as usual.

Exiting the operating menu – EXIT

Via the “EXIT” menu, you can exit the operating menu and return to the standard display.

Troubleshooting

Error checklist

Problem	Possible cause	Possible solution
No operation indication	Batteries are flat or accupack is flat	Replace the batteries or recharge the accupack
No RF signal	Receiver and transmitter are not on the same channel	Set receiver and transmitter to the same channel
	Transmitter is out of range	Check the squelch threshold setting or reduce the distance between transmitter and receiving antenna
RF signal available, no audio signal, "MUTE" display appears on the display panel	Transmitter is muted ("MUTE")	Deactivate the muting function (see operating manual of the transmitter)
	Receiver's squelch threshold is adjusted too high	See "Adjusting the squelch threshold" on page 23
	Transmitter doesn't transmit a pilot tone	Switch the pilot tone transmission on the transmitter on or switch the pilot tone evaluation on the receiver off
Audio signal has a high level of background noise	Transmitter sensitivity is adjusted too low	Adjust the transmitter sensitivity correctly
	Receiver's AF output level is adjusted too low	See "Adjusting the audio output level" on page 23
Audio signal is distorted	Transmitter sensitivity is adjusted too high	Adjust the transmitter sensitivity correctly
	Receiver's AF output level is adjusted too high	See "Adjusting the audio output level" on page 23
No access to a certain channel	During scanning, an RF signal has been detected on this channel and the channel has been locked	See "Scanning the channel banks for free channels" on page 22

If problems occur that are not listed in the above table or if the problems cannot be solved with the proposed solutions, please contact your local Sennheiser agent for assistance.

Recommendations and tips

... for optimum reception

- Transmission range depends to a large extent on location and can vary from about 10 m to about 150 m. There should be a "free line of sight" between transmitting and receiving antennas.
- To avoid overmodulating the receiver, observe a minimum distance of 5 m between transmitting and receiving antennas.

... for multi-channel operation

- For multi-channel operation, you can only use the channels in a channel bank. Each of the channel banks "1" to "8" accommodates up to 20 factory-preset frequencies which are intermodulation-free. For alternative frequency combinations, please refer to the enclosed frequency table. The freely selectable frequencies can be selected via the "TUNE" menu and can be stored in the channel bank "U".
- When using several transmitters simultaneously, interference can be avoided by maintaining a minimum distance of 20 cm between two transmitters.

Care and maintenance

Use a slightly damp cloth to clean the receiver from time to time.

Note:

Do not use any cleansing agents or solvents.

Additional information

HDX noise reduction

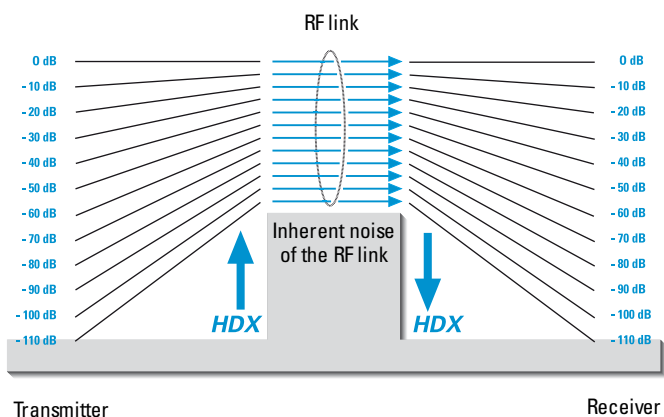

Progress you can hear:

The evolution wireless G2 series is equipped with HDX, the Sennheiser noise reduction system that reduces RF interference. It increases the signal-to-noise ratio in wireless audio transmission to more than 110 dB.

HDX is a wideband compander system which compresses the audio signal in the transmitter in a 2:1 ratio (related to dB) to lift it above the inherent noise floor of the RF link. A 110 dB dynamic range signal is thus transmitted with an effective dynamic range of only 55 dB, which is above the 60 dB noise floor of the RF link. In the receiver the signal is expanded in an identical and opposite way in a 1:2 ratio to restore the original signal, at the same time reducing the RF noise to below the noise floor of the receiver.

HDX has been specially developed for high quality radiomicrophone systems.

Note:

Only transmitters and receivers that are equipped with HDX can work correctly with each other. If non HDX equipment was mixed with HDX, the dynamic range would be drastically reduced and the transmission would sound blunt and flat. HDX is permanently active and cannot be switched off.

Wireless transmission systems

With the ew 500 G2 series, Sennheiser puts an end to cable tangles and enables complete freedom of movement. The systems operate exclusively in the UHF band. UHF transmission is extremely reliable and is far less prone to interference than the overcrowded VHF band – harmonics from mains units, fluorescent tubes, refrigerators, computers, etc. are virtually eliminated. Also indoor propagation of UHF radio waves is better than VHF so that the RF power can be kept low – this is also an advantage

when using multi-channel systems. Finally, UHF frequency ranges are being approved all over the world for radiomicrophone usage – in some countries licence-free.

Squelch

Pilot tone squelch

The ew 500 G2 transmitters add a pilot tone to the audio signal. The receiver checks incoming audio signals to see if the pilot tone is present. In the absence of the pilot tone, the receiver's audio output will remain muted, even if a strong RF signal is present.

This prevents strong interfering signals from causing hissing noise in the receiver when the transmitters are switched off.

In order to benefit from this feature, the pilot tone function must be activated on both the transmitter and the receiver. The receiver's pilot tone function is factory-preset to "ON" (= activated).

Field strength-dependent squelch

Depending on the strength of the received RF signal, the receiver's audio output is opened or muted. Via the "SQELCH" menu of the receiver, the squelch threshold can be adjusted in three steps (LO, MID, HI).

Specifications

RF characteristics

Modulation	wideband FM
Frequency ranges	518–554, 626–662, 740–776, 786–822, 830–866 MHz
Receiving frequencies	8 channel banks with up to 20 factory-preset channels each 1 channel bank with up to 20 freely selectable channels (1440 frequencies, tunable in steps of 25 kHz)
Switching bandwidth	36 MHz
Nominal/peak deviation	± 24 kHz / ± 48 kHz
Frequency stability	$\leq \pm 15$ ppm
Receiver principle	non diversity
Sensitivity (with HDX, peak deviation)	$< 2.5 \mu\text{V}$ at 52 dB _{A_{rms} S/N}
Adjacent channel rejection	≥ 70 dB
Intermodulation attenuation	≥ 70 dB
Blocking	≥ 80 dB
Squelch	4 steps: OFF LO: 5 dB μV MID: 15 dB μV HI: 25 dB μV

AF characteristics

Noise reduction system	Sennheiser HDX
AF frequency response	40–18,000 Hz
S/N ratio (at 1 mV and peak deviation)	≥ 115 dB(A)
THD (at nominal deviation and 1 kHz)	≤ 0.9 %
AF output voltage (at peak deviation 1 kHz _{AF})	3.5 mm jack socket, balanced: +17 dB _u

Overall unit

Temperature range	– 10 °C to + 55 °C
Power supply	2 AA size batteries, 1.5 V
Power consumption	approx. 150 mA
Power consumption with switched-off receiver	$\leq 250 \mu\text{A}$
Operating time (with batteries)	8–12 hours (depending on volume)
Operating time (with BA 2015 accupack)	8–12 hours (depending on volume)
Dimensions [mm]	82 x 64 x 24
Weight (incl. batteries)	approx. 158 g

Connector assignment

3.5 mm jack plug,
unbalanced

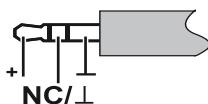

3.5 mm jack plug,
balanced

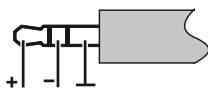

Accessories

BA 2015

Accupack

L 2015

Charger for BA 2015 accupack

DC 2

DC power adapter for external 12 V DC
powering of EK 500 G2 (instead of two
AA size batteries)

Manufacturer declarations

Warranty regulations

The guarantee period for this Sennheiser product is 24 months from the date of purchase. Excluded are accessory items, rechargeable or disposable batteries that are delivered with the product; due to their characteristics these products have a shorter service life that is principally dependent on the individual frequency of use.

The guarantee period starts from the date of original purchase. For this reason, we recommend that the sales receipt be retained as proof of purchase. Without this proof (which is checked by the responsible Sennheiser service partner) you will not be reimbursed for any repairs that are carried out.

Depending on our choice, guarantee service comprises, free of charge, the removal of material and manufacturing defects through repair or replacement of either individual parts or the entire device. Inappropriate usage (e.g. operating faults, mechanical damages, incorrect operating voltage), wear and tear, force majeure and defects which were known at the time of purchase are excluded from guarantee claims. The guarantee is void if the product is manipulated by non-authorized persons or repair stations.

In the case of a claim under the terms of this guarantee, send the device, including accessories and sales receipt, to the responsible service partner. To minimize the risk of transport damage, we recommend that the original packaging is used. Your legal rights against the seller, resulting from the contract of sale, are not affected by this guarantee.

The guarantee can be claimed in all countries outside the U.S. provided that no national law limits our terms of guarantee.

CE Declaration of Conformity

CE 0682

This equipment is in compliance with the essential requirements and other relevant provisions of Directives 1999/5/EC or 89/336/EC. The declaration is available on the internet site at www.sennheiser.com.

Before putting the device into operation, please observe the respective country-specific regulations!

Batteries or rechargeable batteries



The supplied batteries or rechargeable batteries can be recycled. Please dispose of them as special waste or return them to your specialist dealer. In order to protect the environment, only dispose of exhausted batteries.

WEEE Declaration



Your Sennheiser product was developed and manufactured with high-quality materials and components which can be recycled and/or reused. This symbol indicates that electrical and electronic equipment must be disposed of separately from normal waste at the end of its operational lifetime.

Please dispose of this product by bringing it to your local collection point or recycling centre for such equipment. This will help to protect the environment in which we all live.

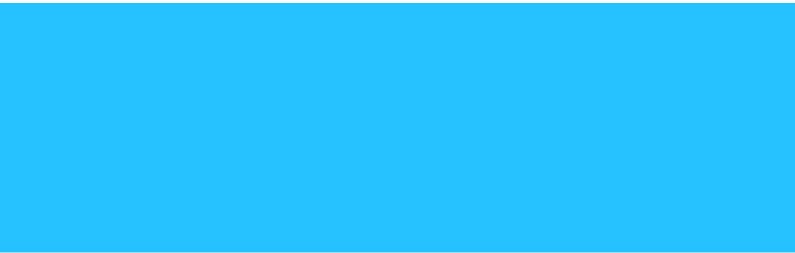

Sennheiser electronic GmbH & Co. KG
30900 Wedemark, Germany
Phone +49 (5130) 600 0
Fax +49 (5130) 600 300
www.sennheiser.com